

▲ Figure 1: TER-AUD-A & ADD-3R-5A Lights Connection Diagram

# TIS TERRE PANEL

Terre Audio Touch Keypad

Model: TER-AUD-A

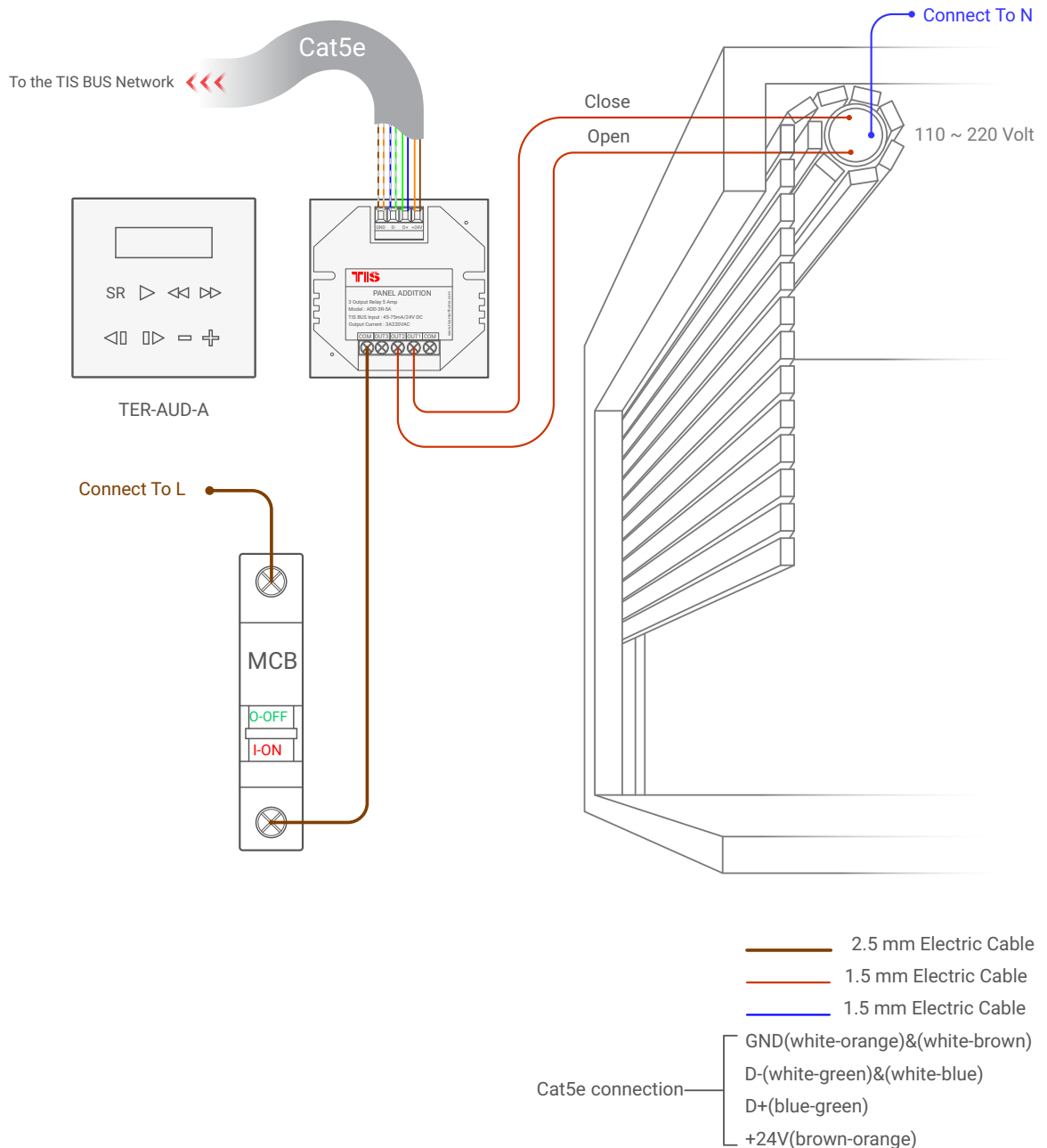
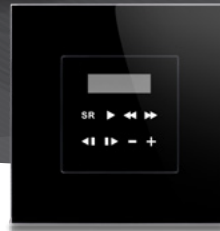

▲ Figure 2: TER-AUD-A & ADD-3R-5A Motors Connection Diagram



Copyright © 2020 TIS, All Rights Reserved  
 TIS Logo is a Registered Trademark of Texas Intelligent System LLC in the United States of America. This company takes TIS Control Ltd. in other countries. All of the Specifications are subject to change without notice.

TEXAS INTELLIGENT SYSTEM LLC  
 SUITE# 610, 860 NORTH DOROTHY DR  
 RICHARDSON  
 TX 75081.USA

TIS CONTROL LIMITED  
 RM 1502-p9 Easey CommBldg  
 253-261 Hennessy Rd Wanchai  
 Hong Kong

# TIS TERRE PANEL

Terre Audio Touch Keypad

Model: TER-AUD-A

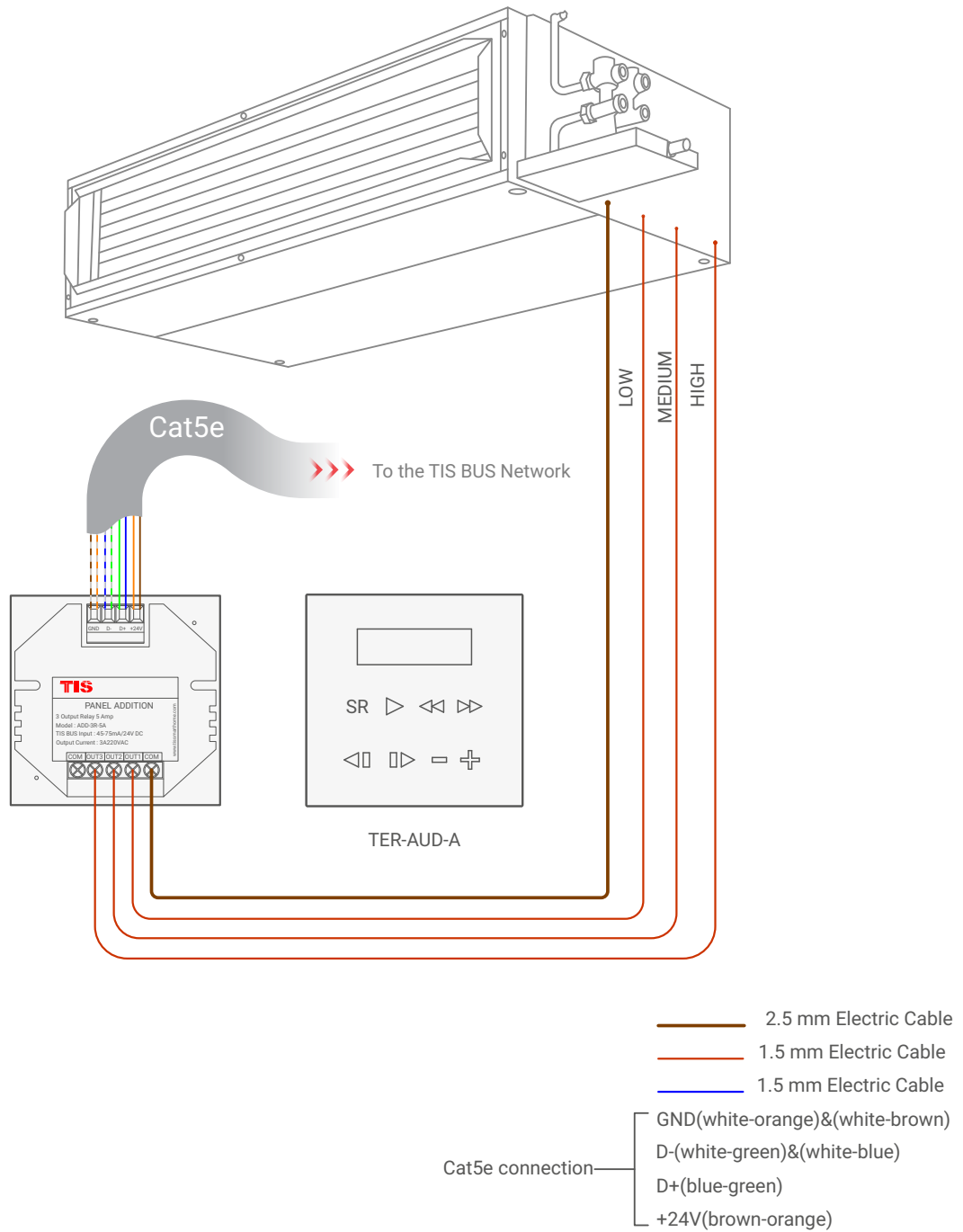
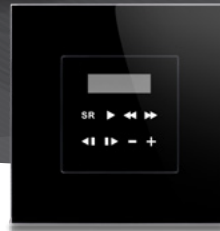

▲ Figure 3: TER-AUD-A & ADD-3R-5A FCU Connection Diagram



Copyright © 2020 TIS, All Rights Reserved  
TIS Logo is a Registered Trademark of Texas Intelligent System LLC in the United States of America. This company takes TIS Control Ltd. in other countries. All of the Specifications are subject to change without notice.

TEXAS INTELLIGENT SYSTEM LLC  
SUITE# 610, 860 NORTH DOROTHY DR  
RICHARDSON  
TX 75081.USA

TIS CONTROL LIMITED  
RM 1502-p9 Easay CommBldg  
253-261 Hennessy Rd Wanchai  
Hong Kong

# TIS TERRE PANEL

Terre Audio Touch Keypad

Model: TER-AUD-A

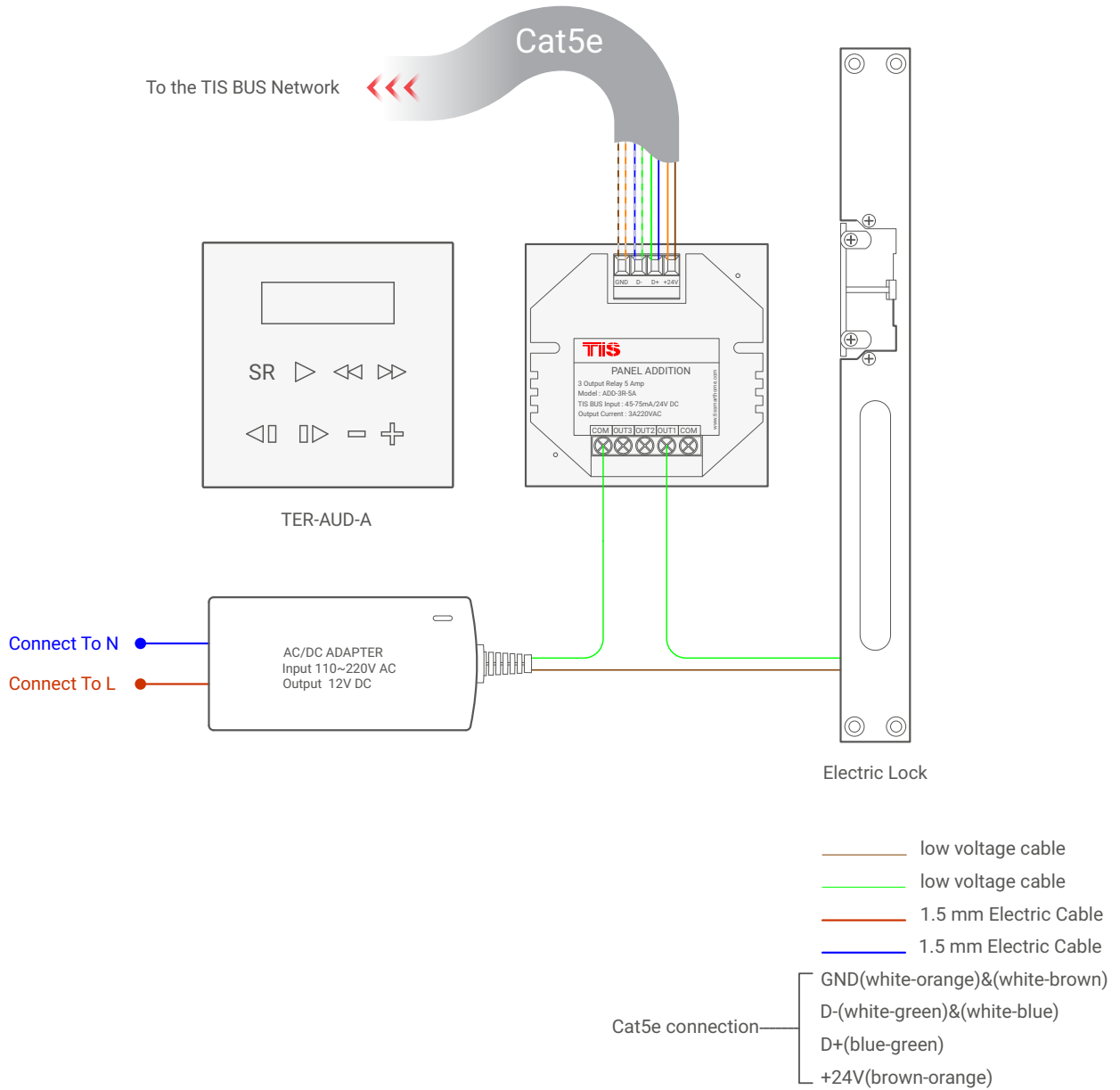
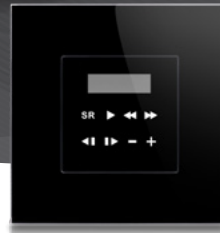

▲ Figure 4: TER-AUD-A & ADD-3R-5A Electric Lock Connection Diagram



Copyright © 2020 TIS, All Rights Reserved  
TIS Logo is a Registered Trademark of Texas Intelligent System LLC in the United States of America. This company takes TIS Control Ltd. in other countries. All of the Specifications are subject to change without notice.

TEXAS INTELLIGENT SYSTEM LLC  
SUITE# 610, 860 NORTH DOROTHY DR  
RICHARDSON  
TX 75081.USA

TIS CONTROL LIMITED  
RM 1502-p9 Easey CommBldg  
253-261 Hennessy Rd Wanchai  
Hong Kong

# TIS TERRE PANEL

Terre Audio Touch Keypad

Model: TER-AUD-A

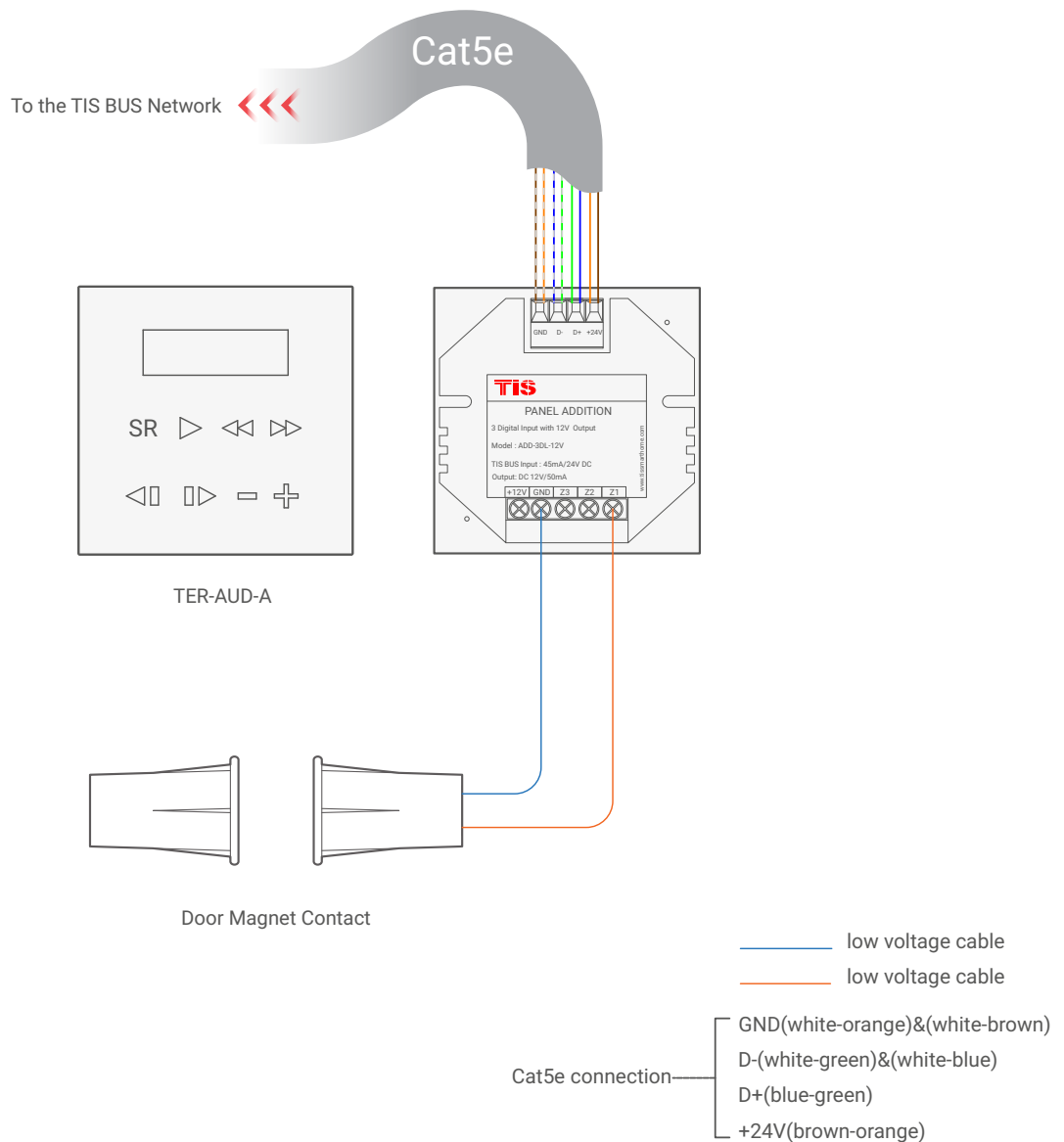
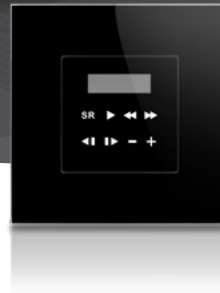

▲ Figure 5: TER-AUD-A & ADD-3DL-12V Magnetic Door Contact Connection Diagram



Copyright © 2020 TIS, All Rights Reserved  
TIS Logo is a Registered Trademark of Texas Intelligent System LLC in the United States of America. This company takes TIS Control Ltd. in other countries. All of the Specifications are subject to change without notice.

TEXAS INTELLIGENT SYSTEM LLC  
SUITE# 610, 860 NORTH DOROTHY DR  
RICHARDSON  
TX 75081.USA

TIS CONTROL LIMITED  
RM 1502-p9 Easey CommBldg  
253-261 Hennessy Rd Wanchai  
Hong Kong



# TIS TERRE PANEL

Terre Audio Touch Keypad

Model: TER-AUD-A

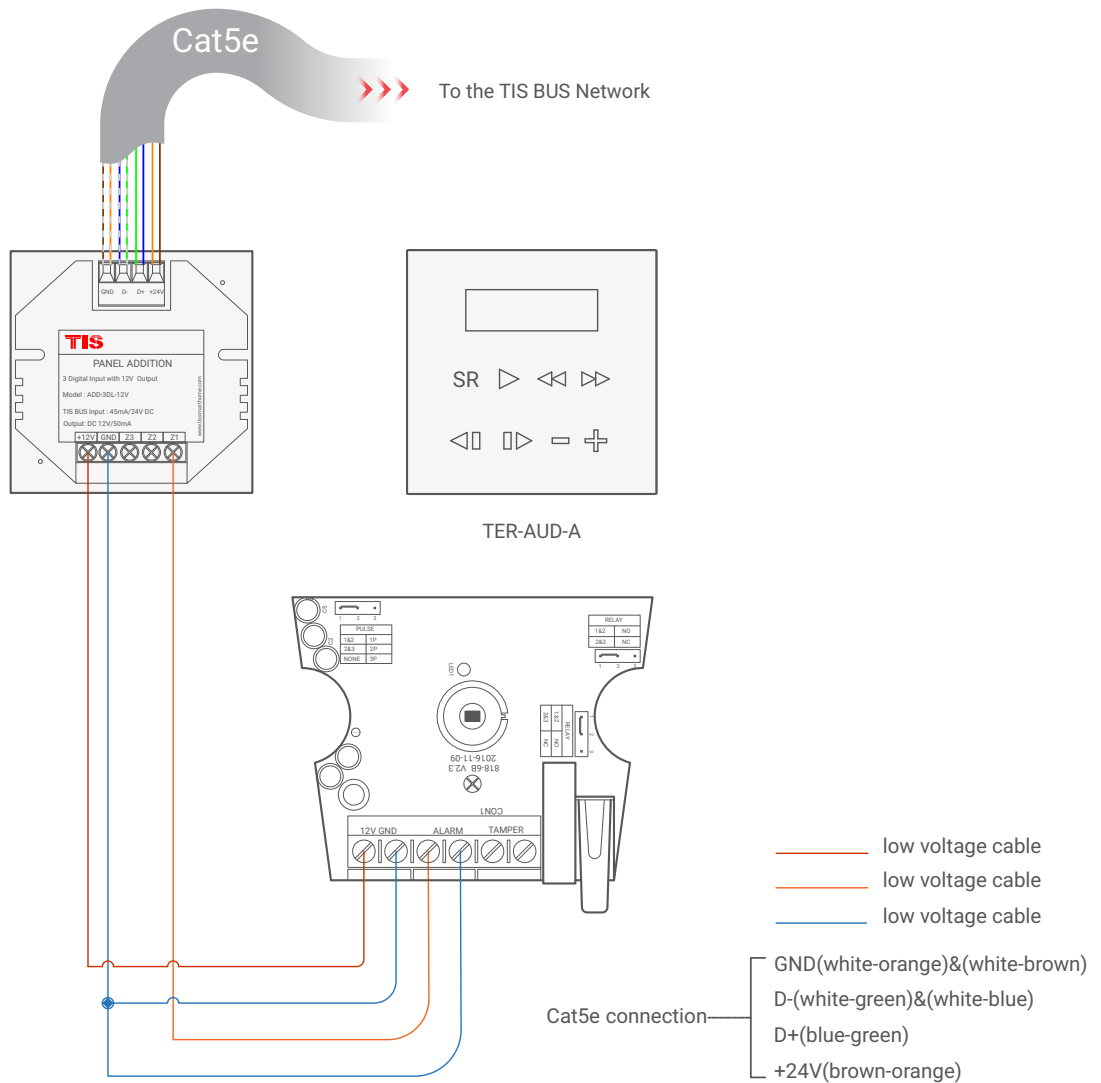
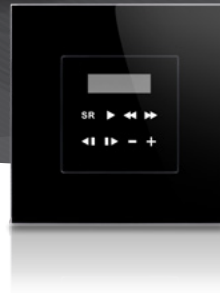

▲ Figure 6: TER-AUD-A & ADD-3DL-12V 3<sup>rd</sup> Party Sensor Connection Diagram



Copyright © 2020 TIS, All Rights Reserved  
 TIS Logo is a Registered Trademark of Texas Intelligent System LLC in the United States of America. This company takes TIS Control Ltd. in other countries. All of the Specifications are subject to change without notice.

TEXAS INTELLIGENT SYSTEM LLC  
 SUITE# 610, 860 NORTH DOROTHY DR  
 RICHARDSON  
 TX 75081.USA

TIS CONTROL LIMITED  
 RM 1502-p9 Easey CommBldg  
 253-261 Hennessy Rd Wanchai  
 Hong Kong

# TIS TERRE PANEL

Terre Audio Touch Keypad

Model: TER-AUD-A

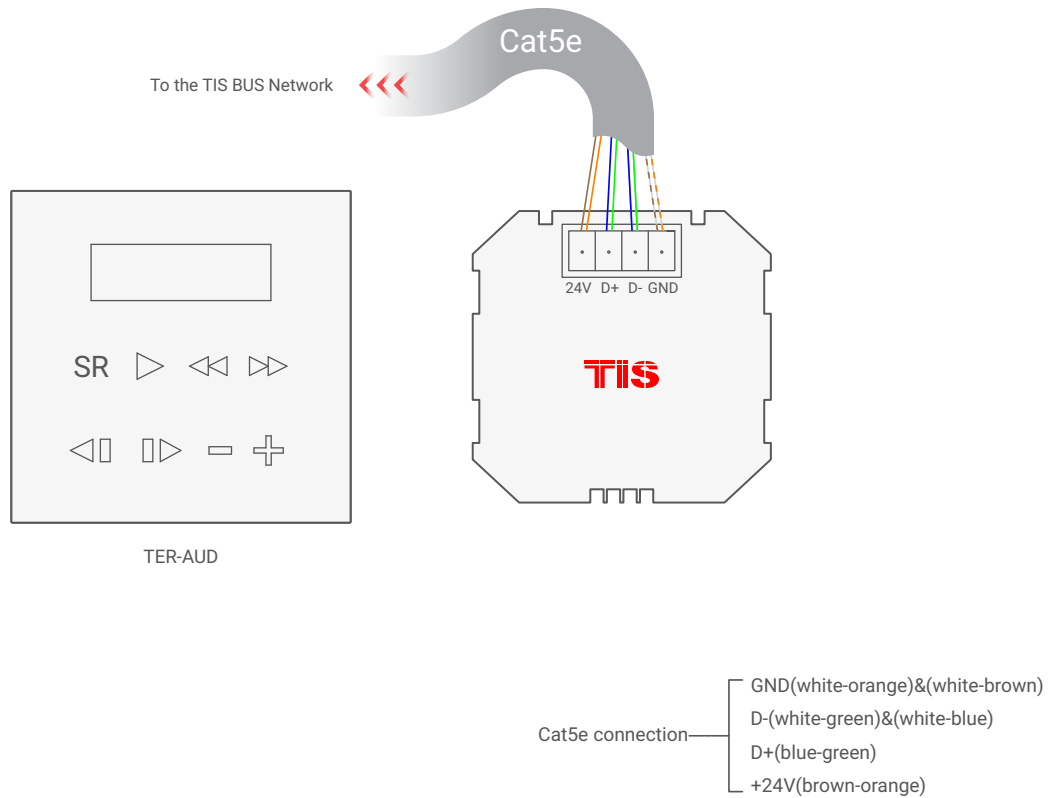
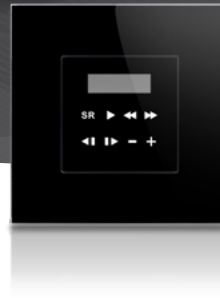

▲ Figure 7: TER-AUD Connection Diagram



Copyright © 2020 TIS, All Rights Reserved  
TIS Logo is a Registered Trademark of Texas Intelligent System LLC in the United States of America. This company takes TIS Control Ltd. in other countries. All of the Specifications are subject to change without notice.

TEXAS INTELLIGENT SYSTEM LLC  
SUITE# 610, 860 NORTH DOROTHY DR  
RICHARDSON  
TX 75081.USA

TIS CONTROL LIMITED  
RM 1502-p9 Easay CommBldg  
253-261 Hennessy Rd Wanchai  
Hong Kong

# TIS TERRE PANEL

Terre Audio Touch Keypad

Model: TER-AUD-A

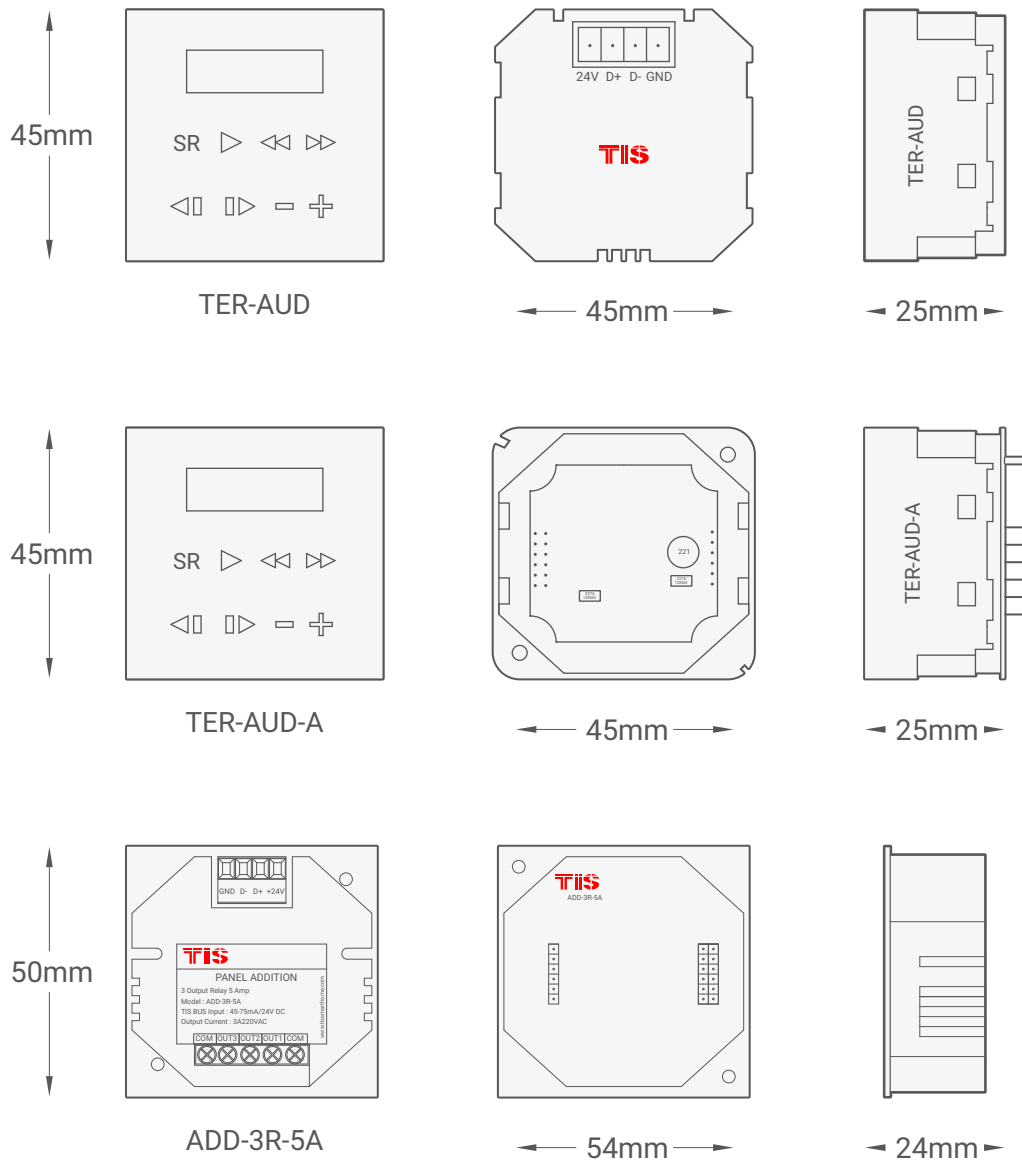
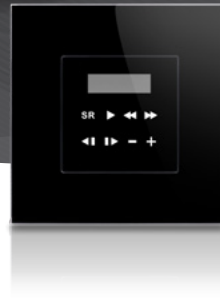

▲ Figure 8: Module's Dimension Diagram



Copyright © 2020 TIS, All Rights Reserved  
 TIS Logo is a Registered Trademark of Texas Intelligent System LLC in the United States of America. This company takes TIS Control Ltd. in other countries. All of the Specifications are subject to change without notice.

TEXAS INTELLIGENT SYSTEM LLC  
 SUITE# 610, 860 NORTH DOROTHY DR  
 RICHARDSON  
 TX 75081,USA

TIS CONTROL LIMITED  
 RM 1502-p9 Easey CommBldg  
 253-261 Hennessy Rd Wanchai  
 Hong Kong